

Mahr

Electronic Caliper Gage for Inside and Outside Dimensions



Marameter 838 EI/EA

Operating Instructions

EN

3722976

Mahr GmbH
Carl-Mahr-Straße 1
37073 Göttingen
Tel. +49 551 7073 0

info@mahr.com, www.mahr.com

0223 / 0689-89



EU/UK Declaration of Conformity

This measuring instrument complies with the applicable EU/UK directives.



A copy of the current Declaration of Conformity is available to download at www.mahr.com/products on the page for the relevant product and can be requested from the following address:

Mahr GmbH, Carl-Mahr-Straße 1, D-37073 Göttingen

Confirmation of traceability

We declare under our sole responsibility that this product is in conformity with standards and technical data as specified in our sales documents (operating instructions, leaflet, catalogue).

We certify that the measuring equipment used to check this product, and guaranteed by our Quality Assurance, is traceable to national standards.

Thank you very much for your confidence in purchasing this product.

Notes for disposal

Dear Customer

This measuring instrument contains a non-rechargeable lithium battery. Spent batteries may not be disposed of in household waste. Waste batteries contain hazardous substances which can be harmful to the environment and to human health. Waste batteries and accumulators must either be returned to an outlet where batteries and accumulators are sold, or taken to a municipal collection point. There is a legal obligation on suppliers to take back batteries free of charge. Please dispose of discharged batteries only, in the collection containers provided. When disposing of lithium batteries please tape over the poles.

The removal of batteries is described in the instrument's operating instructions.

All batteries can be recycled. Valuable raw materials such as iron, zinc and nickel can be recovered in this way, thereby helping to protect the environment.

Electronic equipment which was purchased from us after March 23, 2006 can be returned to us. We will dispose of this equipment in an environmentally-friendly way in accordance with the applicable EU Directives WEEE (Waste Electrical and Electronic Equipment and the German National - Electrical and Electronic Equipment Act, ElektroG).



Permitted use

The electronic caliper gage Marameter 838 EI / EA is to be used to determine length measurements and can be employed in production, quality control and in the workshop.

Permitted use is subject to compliance with all published information relating to this product. Any other use is not in accordance with the permitted use. The manufacturer accepts no liability for damages resulting from improper use. All statutory and other regulations and guidelines applicable to the area of use must be observed.

In order to achieve the best use of this instrument it is most important that you read the operating instructions first.

Delivery

- Caliper gage
- 2 Batteries, Type AAA
- Cross tip (Philips) screwdriver (for changing the battery)
- Operating instructions
- Test report

Table of contents

	Page
1. Important hints prior to initial operation	4
2. Technical Data	5
3. Functions and description	7
4. Preparing to use the gage / Changing the battery.....	9
5. General advice on measuring with the caliper gage	10
6. Handling for dynamic measurements.....	11
7. Program: Absolut/Relativ, MIN/MAX/HOLD	12
7.1 Initial State	12
7.2 Absolute and Relative Mode	12
7.3 Measuring Programs	12
8. Program Tolerance (TOL)	13
8.1 Accessing the tolerance range selection	13
8.2 Selection and confirmation of the tolerance range	13
8.3 Deactivation of the tolerance function	13
9. Key Lock. Deactivation of the key lock	14
10. Data Logger (D-LOG)	14
11. Back Button	14
12. SETUP-Menu	15
12.1 Accessing the setup menu	15
12.2 Switch between menu items and selection	15
12.3 Zero Point Correction (OFFSET).	15
12.4 Tolerance Program (TOL). Setting the tolerance limits	16
12.5 Switching MM/INCH (UNIT).	16
12.6 Choice of Scale Division Value (SCALE)	17
12.7 Auto-Power-OFF (A-OFF)	17
12.8 Data Logger (D-LOG)	17
12.9 Factory Settings (RESET)	19
12.10 Vibration (VIBRAT)	19
13. Error Messages	19
14. Accessories	20

1 Important hints prior to initial operation

- In order to ensure a long use of this caliper gage, any contamination on the measuring instrument must be removed immediately after completion of usage. This can be done with a dry cloth. Subsequently, to conserve the metal components, these should be lightly smeared with flushing oil.
- Protect the data output opening with the respective cover when not in use.
- Clean the housing with a dry, soft cloth. Remove heavy soiling with a slightly moistened cloth. Volatile organic solvents like thinners are not to be used, as these liquids can damage the housing.
- Unauthorized opening of the instrument forfeits the warranty.
- This measuring gage is manufactured with high precision parts and carefully adjusted. Therefore never try to disassemble or change any of the interior parts of this gage. Prior to each series of measurements, the gage is to be tested through a comparison measurement with an adjustment ring/gage block!
- When the „Low-Bat“ symbol appears the intended operation or function can no longer be guaranteed.
- If your actual measuring problem cannot be solved with this particular gage then please inform us of your measuring task and we can suggest another gage that will fulfill your requirements.

We wish you a satisfactory and long service with your measuring instrument. Should you have any questions regarding the instrument, contact us and we shall be pleased to answer them.

- **Battery**



- **not rechargeable**
- **do not incinerate**
- **dispose off as prescribed**

! Do not use an electric marking tool on the caliper gage.

2 Technical Data

838 EA Electronic caliper gage for outside dimensions

Order no.			4495450	4495451	4495452	4495453
Measuring Range	Meb	mm	0 - 10	0 - 20	0 - 20	0 - 30
Resolution switchable		mm	0,001 / 0,002 / 0,005 / 0,01 / 0,02 / 0,05			
Resolution switchable		inch	.00005" / .0001" / .0002" / .0005" / .001" / .002"			
Error limit	MPE _E	mm	0,015	0,03	0,03	0,04
Repeatability limit	MPE _R	mm	0,005	0,01	0,01	0,02
Measuring force	F	N	0,8 - 1,2	1,1 - 1,6	1,1 - 1,6	0,9 - 1,6
Measuring contact	Ball-∅	mm	1,5	1,5	1,5	3,0
Protection class			IP67			
Max. adjustable OFFSET		mm	±0,3	±0,6	±0,6	±0,9
Reference temperature		°C	+20			
Operating temperature		°C	+10 to +30			
Storage temperature		°C	-10 to +50			
Display			LCD analog / digital			
Data output			USB + DIGIMATIC + Bluetooth BT 4.0			
Power supply			2 x 1,5 V Micro AAA / LR03			

838 EA Electronic caliper gage for outside dimensions

Order no.			4495454	4495455	4495456
Measuring Range	Meb	mm	0 - 50	0 - 30	0 - 50
Resolution switchable		mm	0,001 / 0,002 / 0,005 / 0,01 / 0,02 / 0,05		
Resolution switchable		inch	.00005" / .0001" / .0002" / .0005" / .001" / .002"		
Error limit	MPE _E	mm	0,05	0,04	0,05
Repeatability limit	MPE _R	mm	0,03	0,02	0,03
Measuring force	F	N	0,8 - 1,7	0,9 - 1,6	0,8 - 1,7
Measuring contact	Kugel-∅	mm	3,0	3,0	3,0
Protection class			IP67		
Max. adjustable OFFSET		mm	±1,5	±0,9	±1,5
Reference temperature		°C	+20		
Operating temperature		°C	+10 to +30		
Storage temperature		°C	-10 to +50		
Display			LCD analog / digital		
Data output			USB + DIGIMATIC + Bluetooth BT 4.0		
Power supply			2 x 1,5 V Micro AAA / LR03		



838 EI Electronic caliper gage for inside dimensions

Order no.			4495460	4495461	4495462	4495463
Measuring Range	Meb	mm	5 - 15	10 - 30	20 - 40	30 - 50
Resolution switchable		mm	0,001 / 0,002 / 0,005 / 0,01 / 0,02 / 0,05			
Resolution switchable		inch	.00005" / .0001" / .0002" / .0005" / .001" / .002"			
Error limit	MPE _E	mm	0,015	0,03	0,03	0,03
Repeatability limit	MPE _R	mm	0,005	0,01	0,01	0,01
Measuring force	F	N	0,8 - 1,2	1,1 - 1,6	1,1 - 1,6	1,1 - 1,6
Measuring contact	Ball-∅	mm	0,6	1,0	1,0	1,0
Protection class			IP67			
Max. adjustable OFFSET		mm	±0,3	±0,6	±0,6	±0,6

838 EI Electronic caliper gage for inside dimensions

Order no.			4495464	4495465	4495468	4495469
Measuring Range	Meb	mm	40 - 60	50 - 70	13 - 43	30 - 60
Resolution switchable		mm	0,001 / 0,002 / 0,005 / 0,01 / 0,02 / 0,05			
Resolution switchable		inch	.00005" / .0001" / .0002" / .0005" / .001" / .002"			
Error limit	MPE _E	mm	0,03	0,03	0,04	0,04
Repeatability limit	MPE _R	mm	0,01	0,01	0,02	0,02
Measuring force	F	N	1,1 - 1,6	1,1 - 1,6	1,1 - 1,7	1,1 - 1,7
Measuring contact	Ball-∅	mm	1,0	1,0	1,3	1,5
Protection class			IP67			
Max. adjustable OFFSET		mm	±0,6	±0,6	±0,9	±0,9

838 EI Electronic caliper gage for inside dimensions

Order no.			4495470
Measuring Range	Meb	mm	50 - 80
Resolution switchable		mm	0,001 / 0,002 / 0,005 / 0,01 / 0,02 / 0,05
Resolution switchable		inch	.00005" / .0001" / .0002" / .0005" / .001" / .002"
Error limit	MPE _E	mm	0,04
Repeatability limit	MPE _R	mm	0,02
Measuring force	F	N	1,2 - 1,7
Measuring contact	Ball-∅	mm	2,0
Protection class			IP67
Max. adjustable OFFSET		mm	±0,9
Reference temperature		°C	+20
Operating temperature		°C	+10 to +30
Storage temperature		°C	-10 to +50
Display			LCD analog / digital
Data output			USB + DIGIMATIC + Bluetooth BT 4.0
Power supply			2 x 1,5 V Micro AAA / LR03



3 Functions and description

Pos. Description

- 1 Moveable measuring arm
- 2 Fixed measuring arm
- 3 Measuring contact
- 4 Measuring contact
- 5 Operating lever
- 6 LCD display
- 7 Housing
- 8 Operating keys
- 9 Interface port
- 10 Battery cover
- 11 Fastening screws

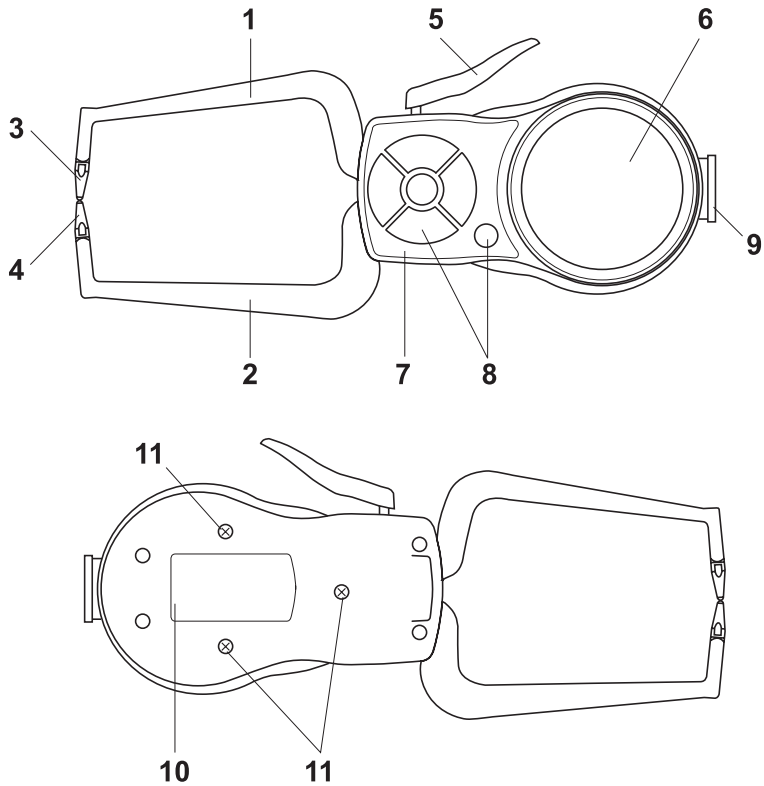

Pos. Description

LCD – Display

- 1 Numerical display
- 2 Scale description
- 3 Analog display
- 4 Measuring programs (footer):
 - 4.1 <0> - Relative mode is activated: 0-Preset with setting gage
 - 4.2 MIN - program is activated: Determination of the minimum measured value
 - 4.3 MAX - program is activated: Determination of the maximum measured value
 - 4.4 HOLD - program is activated: Freezing the currently displayed measured value
- 5 Pointer
- 6 Scale interval
- 7 Measuring range / SETUP-Menu
- 8 Tolerance direction
- 9 +/- display for comparison measurement
- 10 mm - measuring value in millimeter
- 11 inch - measuring value in inch
- 12 LOW BATT activated
- 13 Key lock activated
- 14 DL Data Logger activated
- 15 SET Setup - Menu active
- 16 TOL Tolerance markers
- 17 Bluetooth-connection activated
- 18 LED control signal (blue), tolerance display (red/green)
- 19 Tolerance field marks

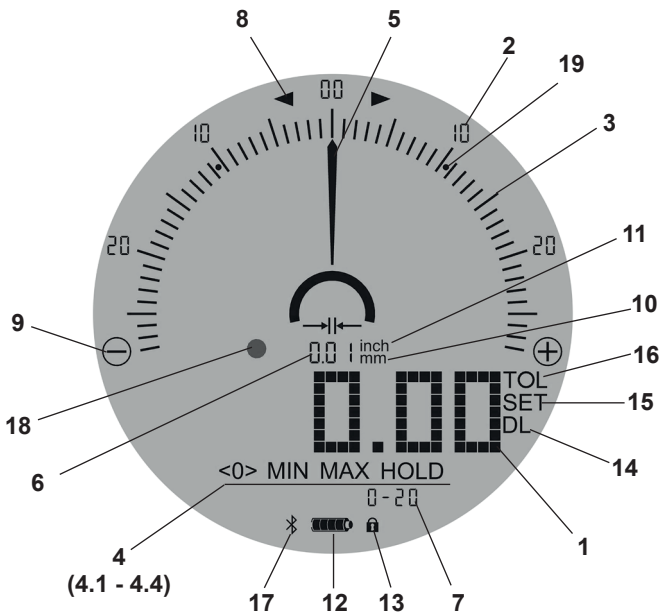

4 Preparing to use the gage / Changing the battery

For the initial use the batteries provided have to be inserted.

- To open the battery cover **10** loosen the screws **11** by using the screwdriver provided and insert the batteries (2x AAA).
- Close the battery cover **10** after changing the batteries and tighten the screws **11**.

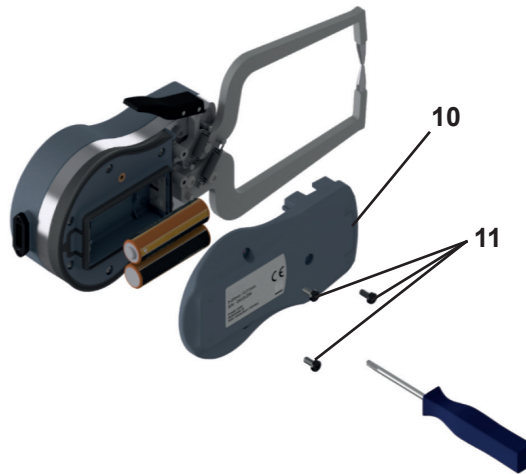

- Insert the battery ensuring correct polarity!
- The batteries provided are not rechargeable!
- Battery type: 2x 1.5V Micro AAA / MN2400 / LR03
- Close battery **10** cover carefully and **pay attention to cleanliness!**
- If the measuring instrument is not used for more than 3 months the batteries must be removed, as a leakage of the battery could cause damage to the measuring instrument.



If **LOW-BATT 15**  appears in the display a change of the battery is urgently necessary.

5 General advice on measuring with the caliper gage

- Please be careful with the measuring contacts (3+4) and the movable operating lever 5 and try to manage the gage in measuring position without touching the workpiece.
- Hold the gage loose during measurement and release the operating lever 5.
- To determine the correct measuring value, please pivot or displace the gage and read from the display the minimum or maximum deflection of the pointer.
- Only the determined measured values that are within the measuring range (see „1. Technical Data“) of this measuring instrument are correct; outside this measuring range may not be measured.
- The gage software is available with different features and options which allows an easy measurement. For more information see Chapter „Measuring programs“.
- Please check the instrument via comparison measurement with a gage block each time before starting a new measurement series (à zero point adjustment).
- To reduce the measuring uncertainty of the measuring instrument, the measuring instrument should be calibrated in the measuring program and in-situ in which the measuring instrument is to be used.
- The instrument starts the first time with „Absolute – Mode“ and „standard program“.
- When starting the instrument the last mode will be shown.
- The gage switches back into the last used measuring mode, if no key has been pushed for more than 30s in the setup menu. Changes in the setup menu will be adopted.

Floating display

Follow up constantly the measured value shown in the display.

When a reverse point is found within a range of ± 20 digits the pointer and the suitable analog bar will be shown.

If a new reversal point of more than ± 20 digits is found the analog bar will be adjusted automatically.

(This program will be started during the first initial use of this measuring instrument or after a reset to the factory settings.)

6 Handling for dynamic measurements. Notes on determining the correct measured values in the MIN / MAX / HOLD programs

Important:

The measuring axis must be in vertical position to the measuring surface!

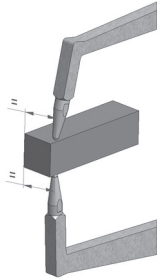

Determination of the **minimum measuring value** via pivoting the gage (optimal measurement)

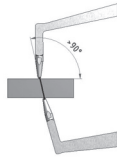

Measuring value
too high

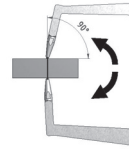

Measuring value
correct



Measuring value
too high

Important:

The measuring axis must be in vertical position to the measuring surface!

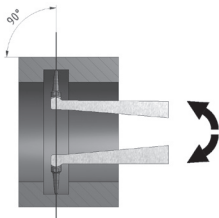

Determination of the **maximum measuring value** for measurement of narrow grooves via radial pivoting of the gage, when the gage cannot be pivoted vertically.

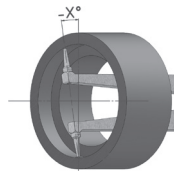

Measuring value
too small

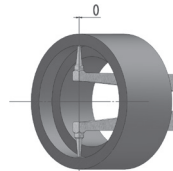

Measuring value
correct

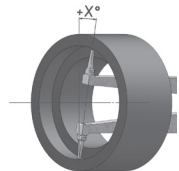

Measuring value
too small

7 Program: Absolut/Relativ, MIN/MAX/HOLD

7.1 Initial State. The initial state is a prerequisite for the functioning of all the programs and setting options described.



00 1 mm
0.00
0-20

7.2 Absolute and Relative Mode. Switching from "Absolute Mode" to "Relative Mode"



00 1 mm
0.00
0-PrE 000

If the „Absolute - Mode“ is activated measurements will be made with reference to the zero point.

(This program will be started during the first initial use of this measuring instrument or after a reset to the factory settings).

If the „Relative - Mode „ is activated measurements will be made with reference to the reference value (gage block), this must be selected beforehand. This mode is used for comparison measurement.

Switching between „Absolute- / Relative - Mode „ can be made in MIN / MAX / HOLD and TOL.

7.3 Measuring Programs. Switching measuring programs (MIN/MAX/HOLD)



■■■■■■■■■■
MIN MAX HOLD
0-20

The Programs MIN / MAX / HOLD can be used for the „Absolute - Mode“ as well as the „Relative - Mode“.

After selecting the Program is always activated without pressing the operating lever again.

8 Program Tolerance (TOL) Aktiviation and Deaktivation the Tolerance function

The TOL-Program is an assistance for checking tolerances during measurements.

Tolerance field marks **19** and the tolerance display, LED signal (red/green) **18** are activated. The red LED lights up for parts exceeding or falling below the tolerance range (rejected parts). The green LED lights up for parts within the tolerance (good part). The tolerance function can be activated in each program (MIN, MAX, HOLD).

Five different tolerance limits are available in „Absolute – Mode“ as well as „REL – Mode“ and work independently.

Please follow the requested requirements of each program for correct measuring results.

The measuring unit („mm“ and „inch“) and scale interval have to be selected before setting the tolerance limits otherwise incorrect measuring results may occur.

8.1 Accessing the tolerance range selection



8.2 Selection and confirmation of the tolerance range

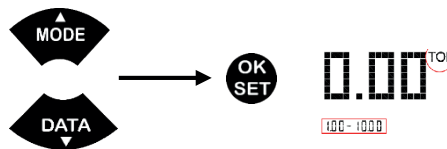

8.3 Deactivation of the tolerance function



9 Key Lock. Deactivation of the key lock. (Key lock reactivates after 20 seconds!)



10 Data Logger (D-LOG). Use Storage of measured values in the internal memory of the device



11 Back Button. One-step jump back



12 SETUP Menu

12.1 Accessing the setup menu



SETUP^{SET}

12.2 Switch between menu items and selection



12.3 Zero Point Correction (OFFSET). Setting the offset value

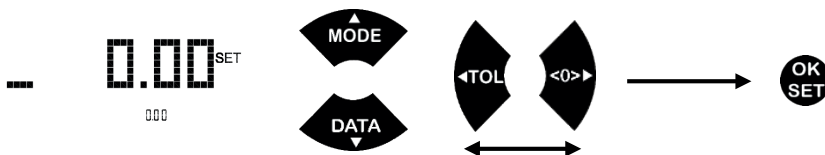

12.4 Tolerance Program (TOL). Setting the tolerance limits

12.4.1 Selecting the tolerance range

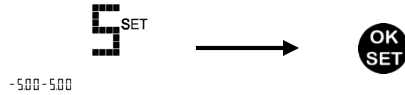

12.4.2 Setting the lower tolerance limit (TOL LO)

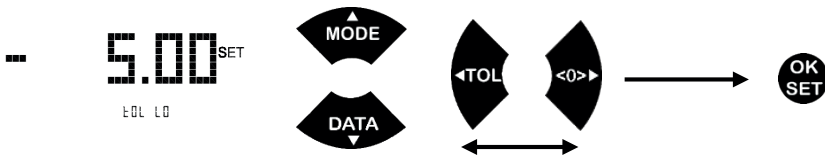

12.4.3 Setting the upper tolerance limit (TOL UP)

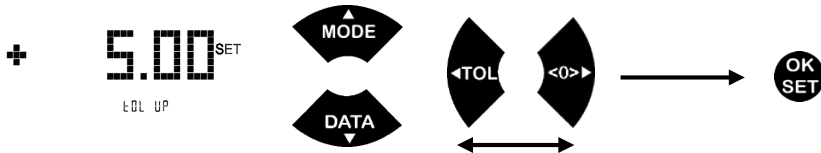

12.5 Switching MM/INCH (UNIT). Selection of the unit of measurement



12.6 Choice of Scale Division Value (SCALE). Selection of the scale resolution

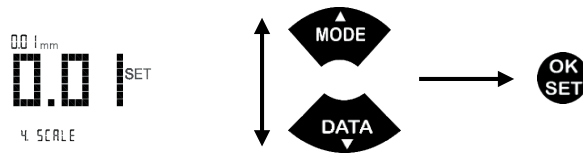

12.7 Auto-Power-OFF (A-OFF). Selection of the time after which the device switches to standby

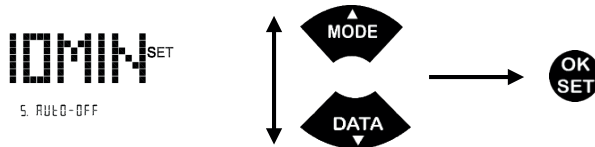

12.8 Data Logger (D-LOG)

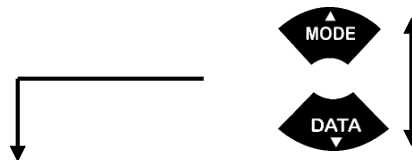

12.8.1 ON Activating the data logger

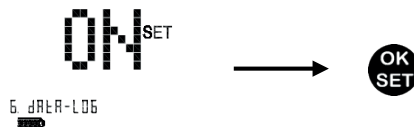

12.8.2 PRINT Printout of the saved measurement values

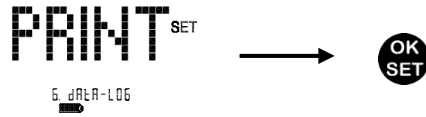

12.8.3 D-OUT Transferring the measurement values to connected peripherals

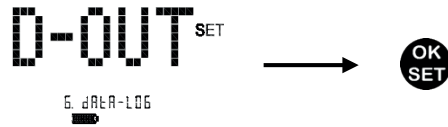

12.8.4 RESET Resetting the D-LOG memory

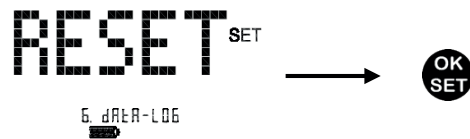

12.8.5 OFF Deactivating the data logger



12.9 Factory Settings (RESET). Reset the device to factory settings

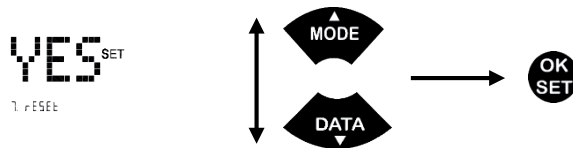

12.10 Vibration (VIBRAT). Activation and deactivation of tactile feedback

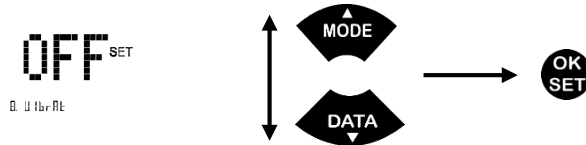

13 Error Messages

- ERR 06 – Tolerance limit outside the permissible range
- ERR 07 – OFFSET outside the permissible range
- ***The device must be sent to the service centre of Mahr to correct this error***
- ERR 08 – Reference point in "Relative Mode" outside the display range
- ERR 09 – No communication with the PC or peripherals
- ERR 10 – Communication breakdown during data transfer
- ERR 11 – Bluetooth connection information has been lost, remove the gauge from all paired devices and start pairing again!
- ERR 12 – Bluetooth connection could not be established after 30 sec., start pairing again!
- ERR 13 – Key(s) blocked or keyboard defective! Please make sure that the keyboard is not being operated

If the error persists, please contact the service center of Mahr

14 Accessories

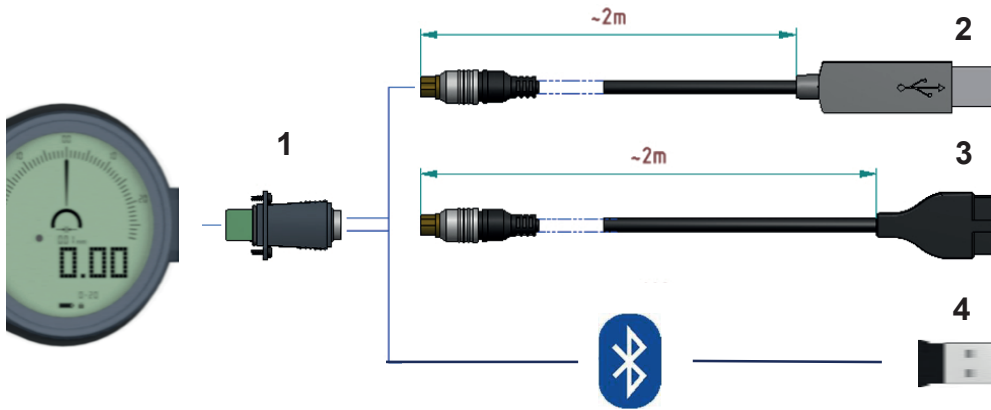

Pos. no.	Order no.	Description
1		Interface Adapter
2	4495079	USB - V2.0 data cable, incl. interface adapter (1)
3	4495083	DIGIMATIC - V2.0 data cable, incl. interface adapter (1)
4	4495036	USB Bluetooth 4.0 dongle, incl. interface adapter (1)